



LOUIS XIV

Davide Groppi / 2023

Louis XIV is the freakiest letter of our light alphabet.
It's a disobedient design that translates a certain rebellion
to common lamp models into light.
I wanted to investigate the idea of the chandelier: in line with our poetics,
Louis XIV is the only possible solution for lightness and irony.
Dimmable suspension lamp with double emission.

LOUIS XIV

Davide Groppi / 2023

Suspension / Direct-Indirect / Indoor

Material Glass - Metal
Finish .19 Polished Gold

Note Suspension luminaire. Eighty crystal drops and a bird. Natural brass branches. Structure with polished gold finish. Matt white rose. Dual emission and on/off. White cable. LOUIS XIV 2: version with power cable only and without rose.

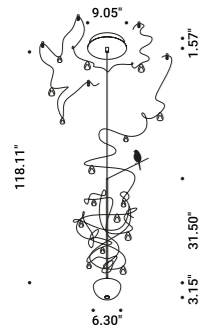

LOUIS XIV 1

Ceiling driver version
 16,5W
 120V - 60Hz
 2700K - Up 890lm - Down 210lm /
 3000K - Up 936lm - Down 235lm
 CRI >90
 UGR <19
 Driver integrated
 TRIAC/IGBT



Polished Gold - 2700K - TRIAC/IGBT
 Polished Gold - 3000K - TRIAC/IGBT

1A4361903.27.02
 1A4361903.30.02

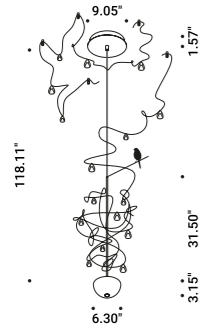

LOUIS XIV 1

Ceiling driver version
 16,5W
 120V - 60Hz
 2700K - Up 890lm - Down 210lm /
 3000K - Up 936lm - Down 235lm
 CRI >90
 UGR <19
 Driver integrated
 DALI - PUSH - 1-10V



Polished Gold - 2700K - DALI - PUSH - 1-10V
 Polished Gold - 3000K - DALI - PUSH - 1-10V

1A4361903.27.07
 1A4361903.30.07

The sizes are expressed in inches.

LOUIS XIV

Davide Groppi / 2023

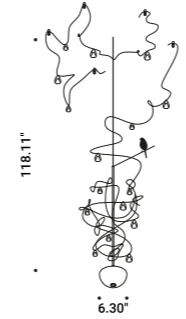

LOUIS XIV 2

Remote driver version
 15W
 Max 250mA DC
 2700K - Up 890lm - Down 210lm /
 3000K - Up 936lm - Down 235lm
 CRI >90
 UGR <19
 Driver not included
 2 Drivers required



Polished Gold - 2700K
 Polished Gold - 3000K

1A4361903.27.20
 1A4361903.30.20

Compulsory accessories

Drivers

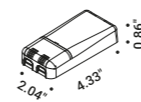
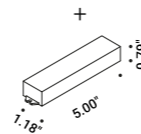
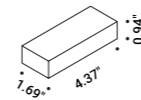

Driver for uplight emission				Not included
120-240V	250mA/12W/IP64/TRIAC - 1-10V	LOUIS XIV 2	1Z2330010	

Driver for downlight emission				Not included
110-240V	250mA/10W/IP20/TRIAC - 1-10V	LOUIS XIV 2	1Z2340010.250	

Driver				Not included
220-240V(110-127V)	250mA/13,5W(13,5W)/IP20/DALI - PUSH	LOUIS XIV 2	1Z0241270.250	- 1-10V

Optional accessories

Suspension kits

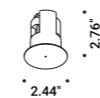

Recessed suspension kit for 0.49" plasterboard				Not included
Matt White	For electrical cables - 1 Piece Plasterboard cut-out Ø 1.73" Minimum space for mounting 2.76"	LOUIS XIV 2	1X0000300.05.00	
Matt Black	For electrical cables - 1 Piece Plasterboard cut-out Ø 1.73" Minimum space for mounting 2.76"	LOUIS XIV 2	1X0000400.05.00	

SUSPENSION KITS

Recessed suspension kit

Suspension kit for 0.49" plasterboard
Plasterboard cut-out Ø 1.73"
Minimum space for mounting 2,76"

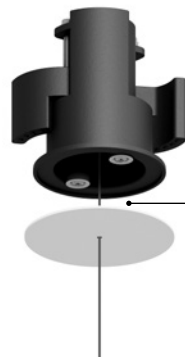
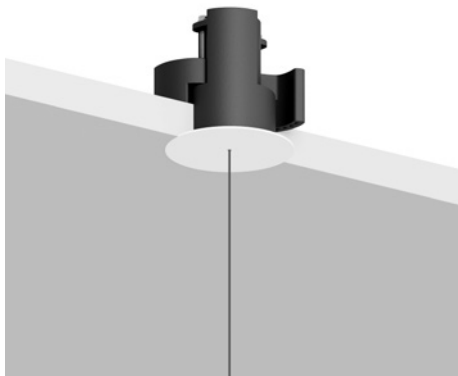

Magnetic fixing
Fissaggio magnetico

Version	Use	Product reference	Finish	Code
Recessed suspension kit.01	For suspension cables	REFLEX S 1	Matt White	1X0000300.01.00
		REFLEX S 2		
Recessed suspension kit.01	For suspension cables	SHANGHAI 1	Matt Black	1X0000400.01.00
		SHANGHAI 2		
		SOTTILE 1		
		SOTTILE 1 DE		
		SOTTILE 2		
		SOTTILE 2 DE		
Recessed suspension kit.02	For electrical cables	MAGIA	Matt White	1X0000300.02.00
			Matt Black	1X0000400.02.00
Recessed suspension kit.03	For suspension cables	MASAI 1	Matt White	1X0000300.03.00
		MASAI 2	Matt Black	1X0000400.03.00
Recessed suspension kit.04	For electrical cables	ASINTOTO	Matt White	1X0000300.04.00
		REFLEX S 2	Matt Black	1X0000400.04.00
	SHANGHAI 2			
		SOTTILE 2		
		SOTTILE 2 DE		
Recessed suspension kit.05	For electrical cables	LOUIS XIV 2	Matt White	1X0000300.05.00
		SOTTOSOPRA 2	Matt Black	1X0000400.05.00

